

LED Exterior Wall Sconce

EW7012
INSTALLATION SHEET

START FROM HERE

- Make sure **POWER** is **COMPLETELY OFF** at the fuse box
- Have your fixture installed by a qualified licensed electrician
- Prepare everything in a clear area
- Wear gloves at all time during this installation
- Read instructions carefully before you start assembly
- Keep this installation sheet for future reference

Technical Support: 1-855-855-8926

Please Note:

- This Kuzco LED fixture comes with pre-wired LED module(s)
- Unless instructed, Do Not touch any part of the LED module(s) as any unnecessary contact with the module could cause permanent damage
- Use ELV (Electronic Low Voltage) type of dimmer for dimming application

- 1.** Remove the fixture from its original packaging
- 2.** Remove the mounting plate (**1c**) from within the fixture (**2a**) by loosening four screws (**2b**)
- 3.** Attach the mounting plate (**1c**) to the electrical junction box (**1a**), using the two screws (**1e**) provided in the hardware package.
- 4.** Make proper electrical connections (black to hot "L", white to neutral "N", ground to "GND") with wire nuts (**1b**) provided in hardware package
- 5.** Attach the fixture (**2a**) onto the mounting plate (**1c**) and secure with four screws (**2b**)
- 6.** To prevent moisture from entering the outlet box and causing a short, seal around the top and side perimeter between the fixture and the wall surface with weather resistant caulking (see illustration 1). The space at bottom should be left un-caulked to prevent moisture build-up.

Illustration 1

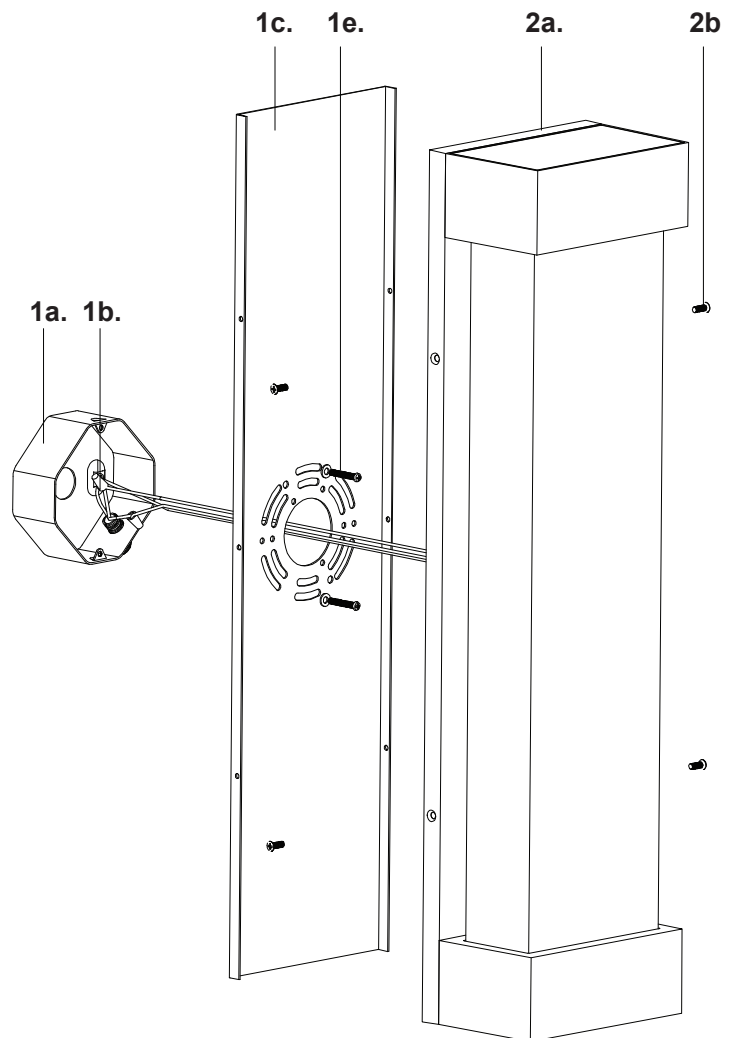
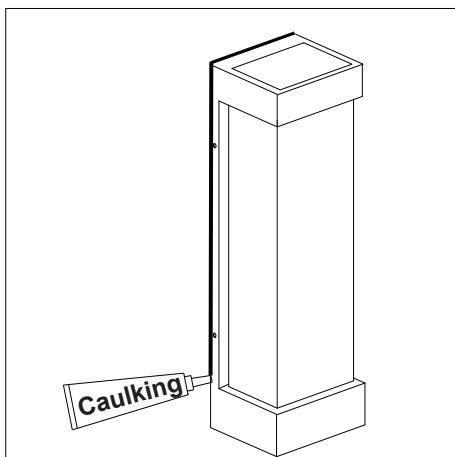

KUZCO

19054 28th Avenue Surrey, BC Canada V3Z 6M3
T: 604 538 7162 TF: 1-855 85 KUZCO F: 604 538 7196
W: kuzcolighting.com
20210108